

FIRST BASE

Tube Clamp DIN3567 (set) model B Ø114

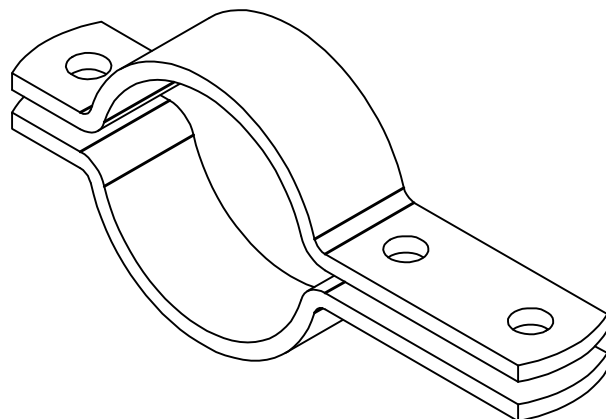

Art. No:	71007
Weight:	2,0 kg
Dimensions:	Product: 296 x 50 x 130 mm
Materials:	Steel grade: S235 Surface treatment: Galvanized acc. to EN-ISO 1461
Installation:	
Use:	Use for all Ø114mm products
Fixation:	M16 Bolts
Products to combine:	Use for all Ø114mm products



3D view (1:3)

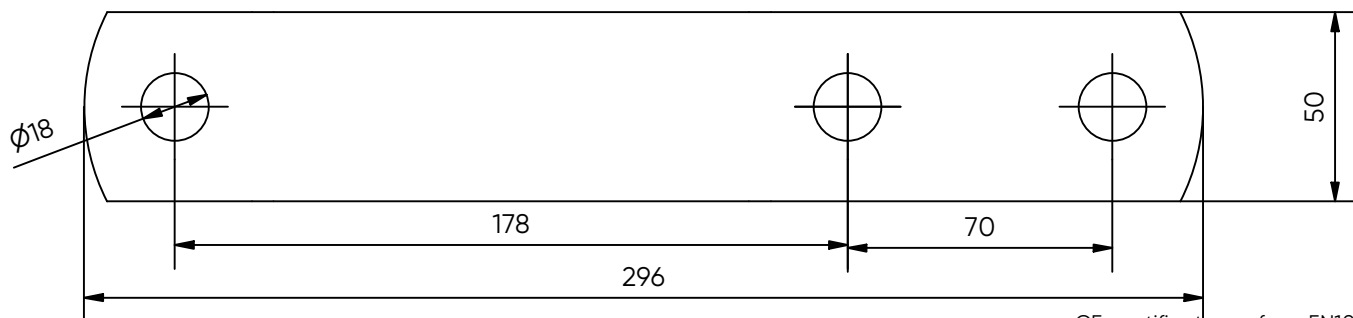
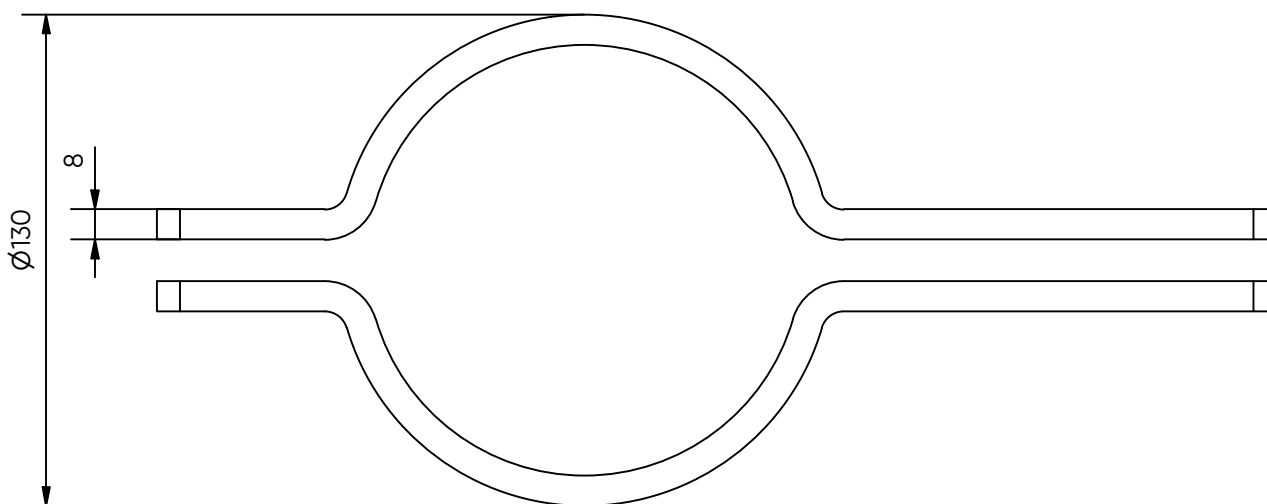

CE-certificate conform EN1090