

FIRST BASE

Tube Clamp DIN 3567 (set) model B Ø89

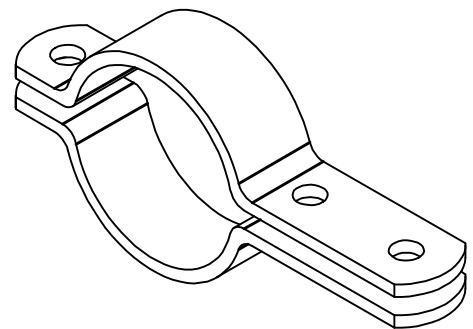

Art. No:	71005
Weight:	0,1 kg
Dimensions:	Product: 230 x 40 x 101 mm
Materials:	Steel grade: S235 Surface treatment: Galvanized acc. to EN-ISO 1461
Installation:	
Use:	Use for all Ø89mm products
Fixation:	M12 Bolts
Products to combine:	Use for all Ø89mm products



3D view (1:3)

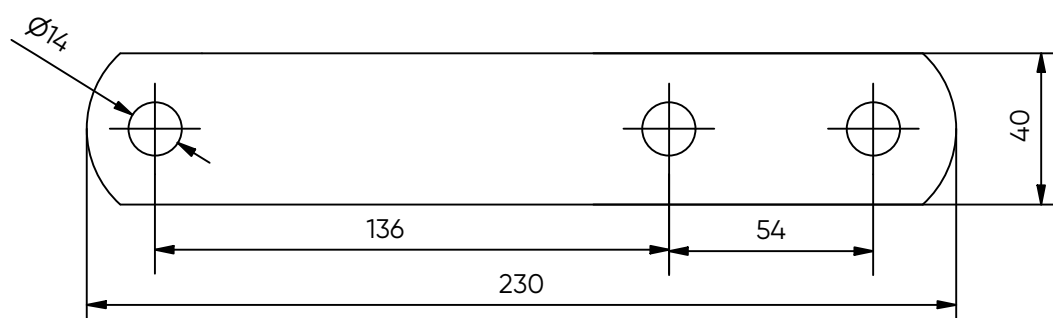
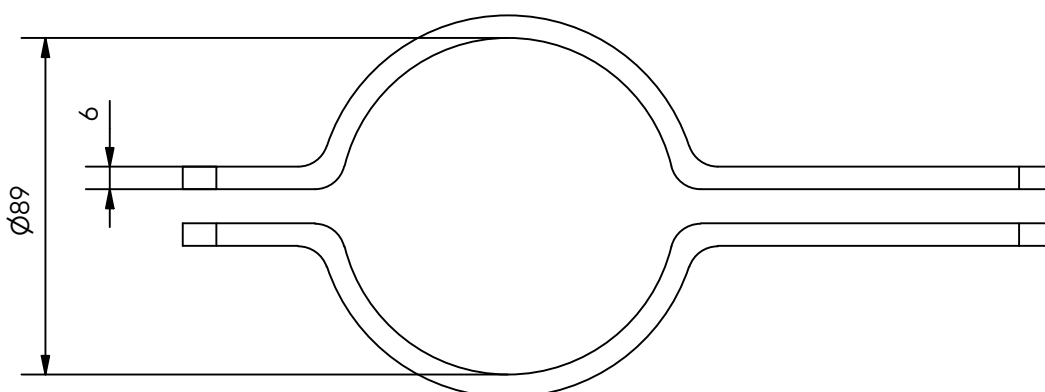

CE-certificate conform EN1090