

FIRST BASE

Tube Clamp DIN3567 (set) model B Ø76

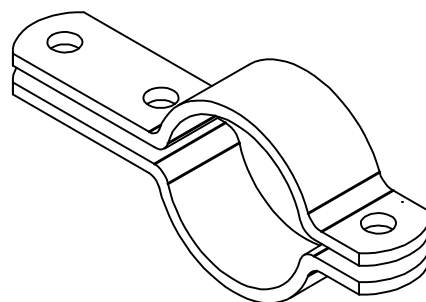

Art. No:	71003
Weight:	0,9 kg
Dimensions:	Product: 212 x 40 x 88 mm
Materials:	Steel grade: S235 Surface treatment: Galvanized acc. to EN-ISO 1461
Installation:	
Use:	Use for all Ø76mm products
Fixation:	M12 Bolts
Products to combine:	Use for all Ø76mm products



3D view (1:3)

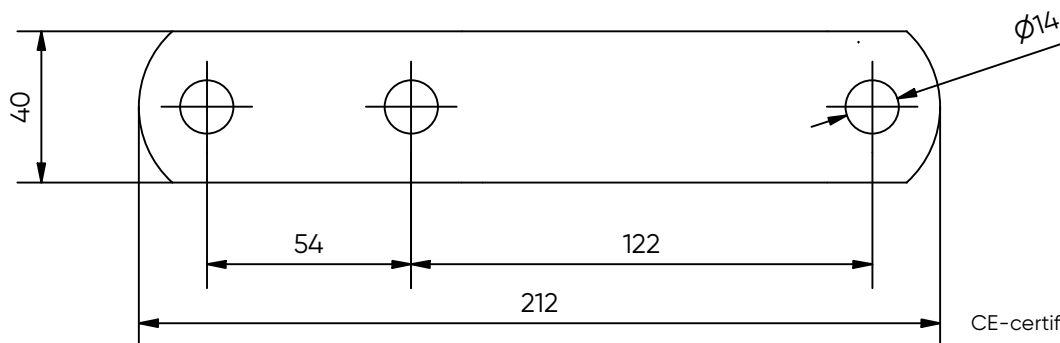
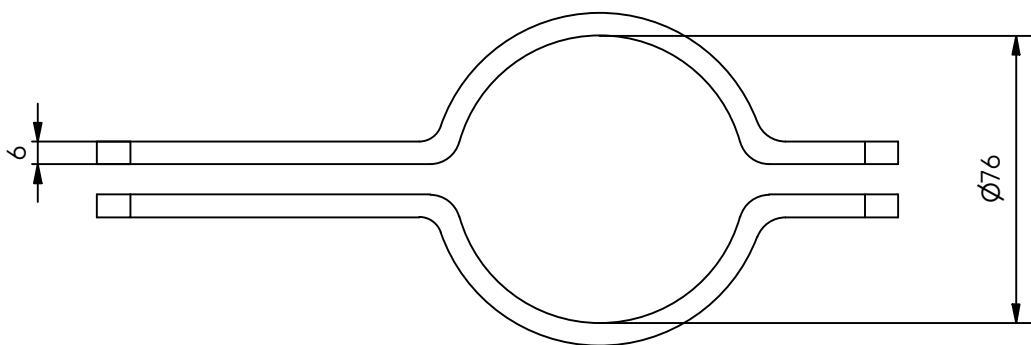

CE-certificate conform EN1090