

FIRST BASE Ground Screw Round Flange

Ø140 x 2600mm - M24



Art. No:	34045
Weight:	38,3 kg
Dimensions:	Pipe: 139,7 x 3,6 x 2600 mm Flange: 12,0 x 260 mm
Materials:	Steel grade Pipe: S235 Steel grade Flange: S355 Surface treatment: Galvanized acc. to EN-ISO 1461
Installation:	Pneumatic machine 10.800Nm Art.No: 12005 Hydraulic machine 12.000Nm Art.No: 120960
Use:	Light construction e.g. porches, garden rooms and modular homes.
Fixation:	M16 , M24 Bolts
Products to combine:	70251 - HE140A STEEL BEAM 1000mm. 70252 - HE140B STEEL BEAM 1000mm. 17022 - L-BRACKET M16 - L-180x202x80x8mm

[Click here for the FIRST BASE Load Capacity Chart](#)

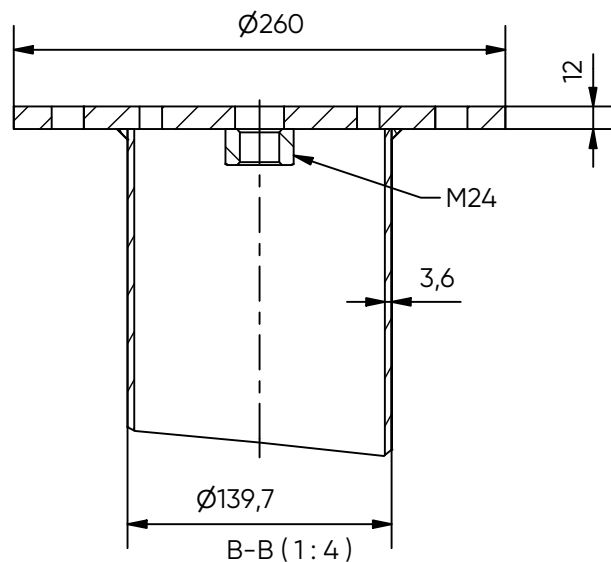
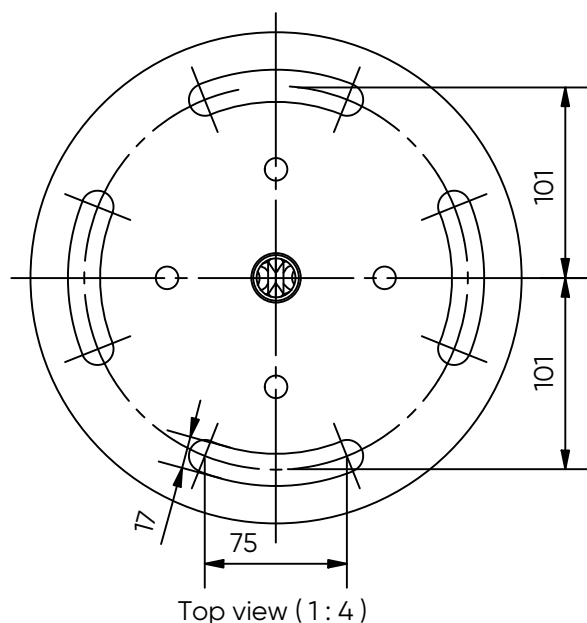
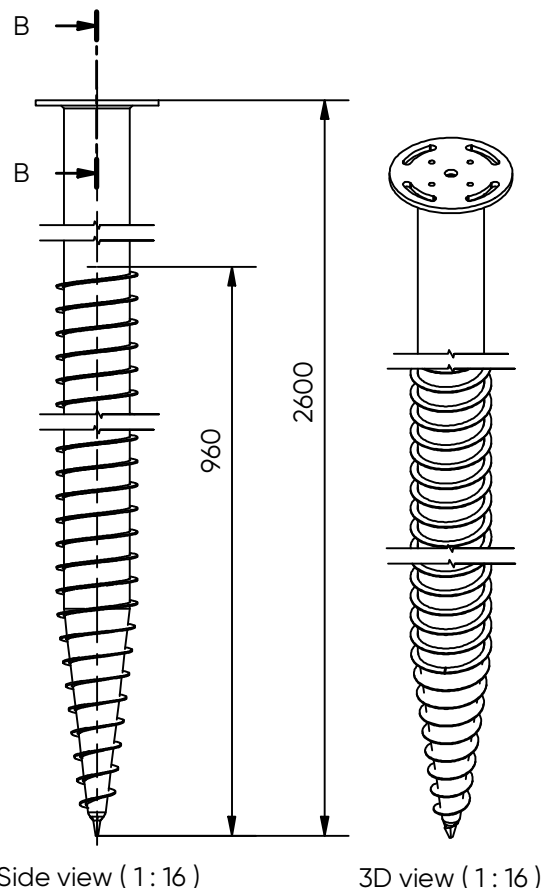

CE-certificate conform EN1090