

FIRST BASE Ground Screw Round Flange

Ø114 x 1600mm - M24

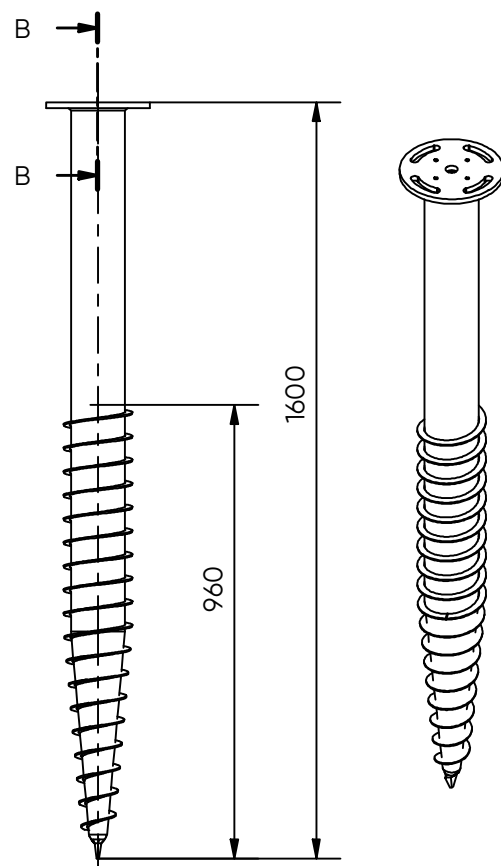

Art. No:	33043
Weight:	19,3 kg
Dimensions:	Pipe: 114,3 x 3,6 x 1600 mm Flange: 12,0 x 220 mm
Materials:	Steel grade Pipe: S235 Steel grade Flange: S355 Surface treatment: Galvanized acc. to EN-ISO 1461
Installation:	Pneumatic machine 10.800Nm Art.No: 12005 Hydraulic machine 12.000Nm Art.No: 120960
Use:	Light construction e.g. porches, garden rooms and modular homes.
Fixation:	M16 , M24 Bolts
Products to combine: 70251 - HE140A STEEL BEAM 1000mm. 70252 - HE140B STEEL BEAM 1000mm. 17022 - L-BRACKET M16 - L-180x202x80x8mm 70103 - FLANGEPLATE ENLARGER 15x320x320mm 8xM16 (S355) 70115 - STEEL SHIM 2x220mm FOR ROUND FLANGE 12x220mm 70116 - STEEL SHIM 5x220mm FOR ROUND FLANGE 12x220mm	
Click here for the FIRST BASE Load Capacity Chart	



Side view (1 : 16)

3D view (1 : 16)

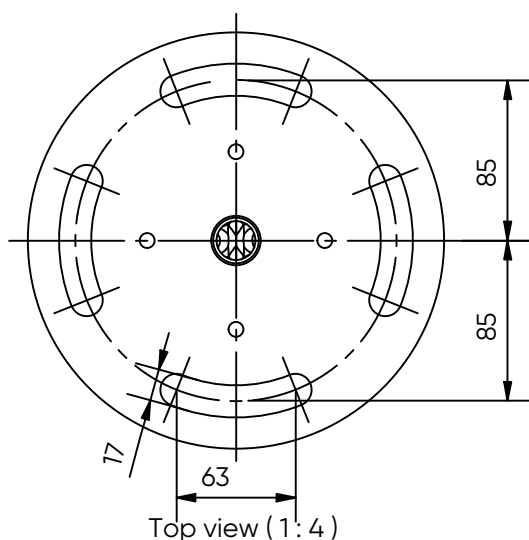

Top view (1 : 4)

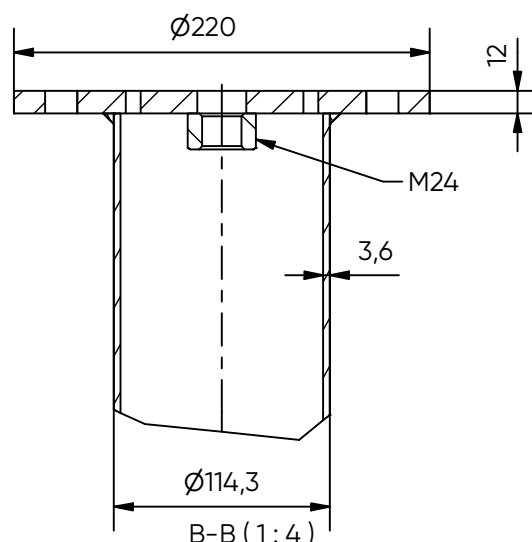

B-B (1 : 4)

CE-certificate conform EN1090